

600V Isolation FRD Module

Description

The Fast Recovery Diode module devices are optimized to reduce losses and EMI/RFI in high frequency power conditioning electrical systems.

The Fast Recovery Diode module is ideally suited for power converters, inverter welders, motor drives and other applications where switching losses are significant portion of the total losses.

Features

- Repetitive Reverse Voltage: $V_{RRM} = 600V$
- Low Forward Voltage: $V_F(\text{typ.}) = 1.3V @ I_F=200A$
- Average Forward Current: $I_{F(AV)} = 200A @ T_C=100^\circ C$
- Reverse Recovery Time: $t_{rr}(\text{typ.}) = 170ns$
- Extensive Characterization of Recovery Parameters
- Reduced EMI and RFI
- Isolation Type Package
- 150°C Operating Junction Temperature
- Built-in Dual FRD Construction

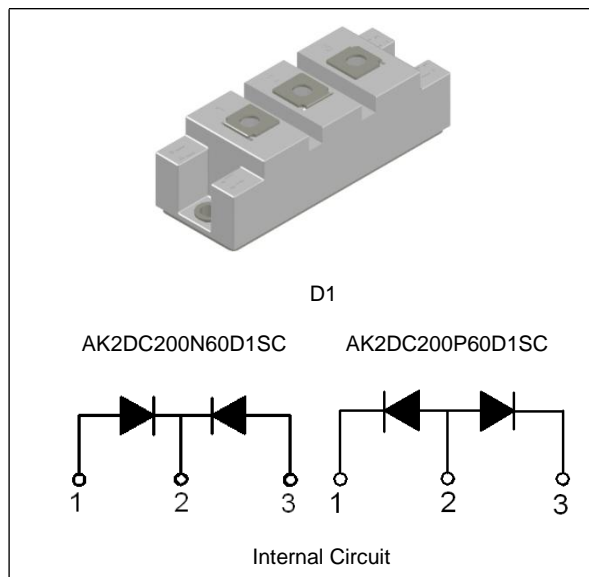

Applications

- High Speed & High Power converters, Inverter Welders
- Various Switching and Telecommunication Power Supply

Absolute Maximum Ratings ($T_C=25^\circ C$, unless otherwise noted)

Symbol	Parameter		Ratings	Unit	
V_{RRM}	Repetitive Peak Reverse Voltage		600	V	
V_R	DC Blocking Voltage		480	V	
$I_{F(AV)}$	Average Rectified Forward Current	Per Diode	$T_C = 25^\circ C$	400	A
			$T_C = 100^\circ C$	200	
		Per Package	$T_C = 25^\circ C$	800	
			$T_C = 100^\circ C$	400	
I_{FSM}	Non-repetitive Peak Surge Current (Per Diode) 60Hz Single Half-sine Wave		2750	A	
I^2t	I^2t For Fusing 60Hz Sine Wave		$31.4 * 10^3$	A ² S	
P_D	Maximum Power Dissipation		550	W	
V_{iso}	Isolation Voltage @AC 1 Minutes		3300	V	
T_J	Junction Temperature		-55 ~ +150	°C	
T_{STG}	Storage Temperature Range		-55 ~ +150	°C	
	Mounting Torque (M5)		4.0	N.m	
	Terminal Torque (M5)		3.0	N.m	
	Weight		145	g	

Electrical Characteristics (Per Diode, $T_C=25\text{ }^\circ\text{C}$, unless otherwise noted)

Symbol	Parameter	Conditions	Min.	Typ.	Max.	Unit
V_F	Forward Voltage Drop	$I_F=200\text{A}$	-	1.3	1.6	V
		$I_F=200\text{A}, T_C=100\text{ }^\circ\text{C}$	-	1.15	-	V
I_{RM}	Reverse Leakage Current	$V_R=600\text{V}$	-	-	0.5	mA
		$V_R=600\text{V}, T_C=100\text{ }^\circ\text{C}$	-	-	1	mA
t_{rr}	Reverse Recovery Time	$I_F=1\text{A}, di/dt=-200\text{A/us}$	-	35	-	ns
t_{rr}	Reverse Recovery Time	$I_F=200\text{A}, di/dt=-200\text{A/us}$	-	170	190	ns
I_{rr}	Reverse Recovery Current		-	17.5	-	A
t_{rr}	Reverse Recovery Time	$I_F=200\text{A}, di/dt=-200\text{A/us}, T_C=100\text{ }^\circ\text{C}$	-	380	-	ns
I_{rr}	Reverse Recovery Current		-	39.0	-	A

Thermal Characteristics

Symbol	Parameter	Ratings	Unit
$R_{th(J-C)}$	Thermal Resistance, Junction to case	0.23	$^\circ\text{C/W}$

Typical Performance Characteristics

Fig. 1. Typical Characteristics: V_F vs. I_F

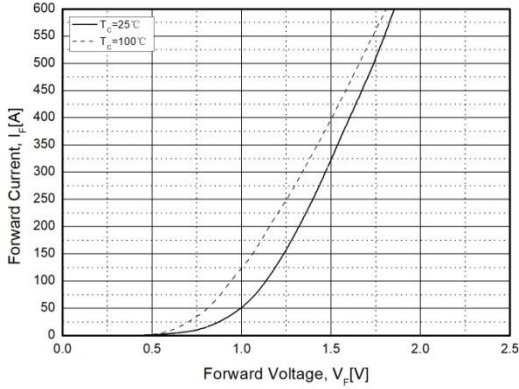

Fig. 2. Typical Reverse Recovery Time vs. di/dt

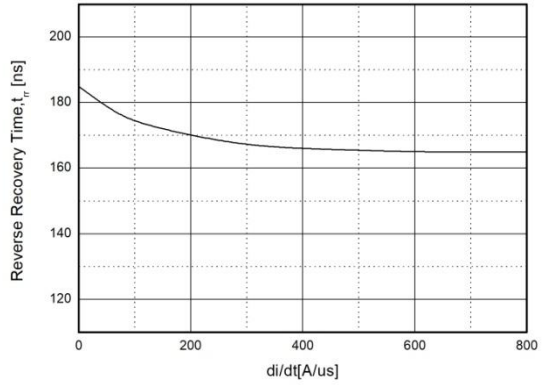

Fig. 3. Transient Thermal Impedance Characteristics ($R_{th(J-C)}$)

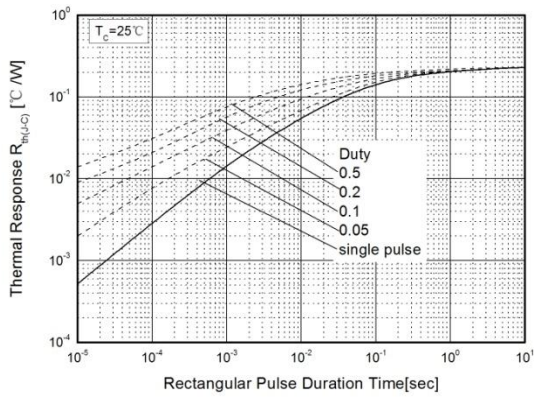
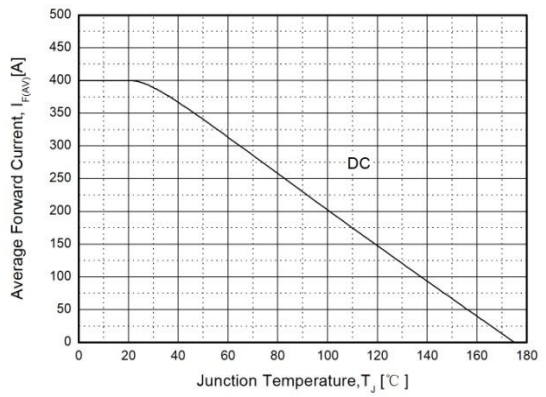
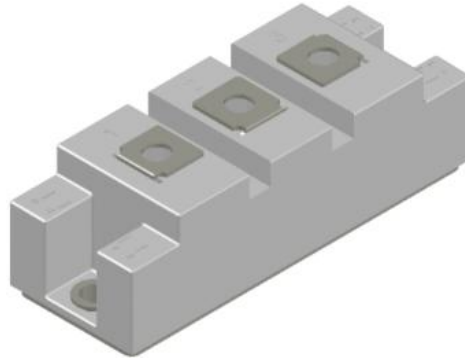

Fig. 4. Forward Current Derating Curve



Package Dimensions

D1



(Dimensions in Millimeters)

